

INNOVATION
WITHOUT LIMITATION

Strategic BOM Management

Rob McAveney

Chief Architect

What is a BOM?



PRODUCT STRUCTURE PHANTOMS
MANUFACTURING SUBSTITUTES
RAW MATERIALS ASSEMBLIES
VARIANTS ENGINEERING
MANUFACTURER PARTS COMPONENTS
PLANNING BILL FUNCTIONAL
SERVICE BOM LOGICAL PARTS
OPTIONS PRODUCTION BOM ALTERNATES

What is a BOM?



The Bill of Materials provides a common language to communicate the composition of a product between different disciplines and organizations at all phases of the product lifecycle

Common BOM Practices



- Managed in many disparate systems
 - Different system per discipline and/or lifecycle phase
 - Excel fills the gaps in enterprise system coverage
 - Manual reentry between systems
- Does not cover the entire product lifecycle
 - No tracking before As-Designed
 - No tracking beyond As-Built
 - No reconciliation between lifecycle phases
- Informal exchange with supply chain
- Treated as just another document instead of a strategic asset

Why Treat BOMs as Strategic?

Increased product complexity is changing the game

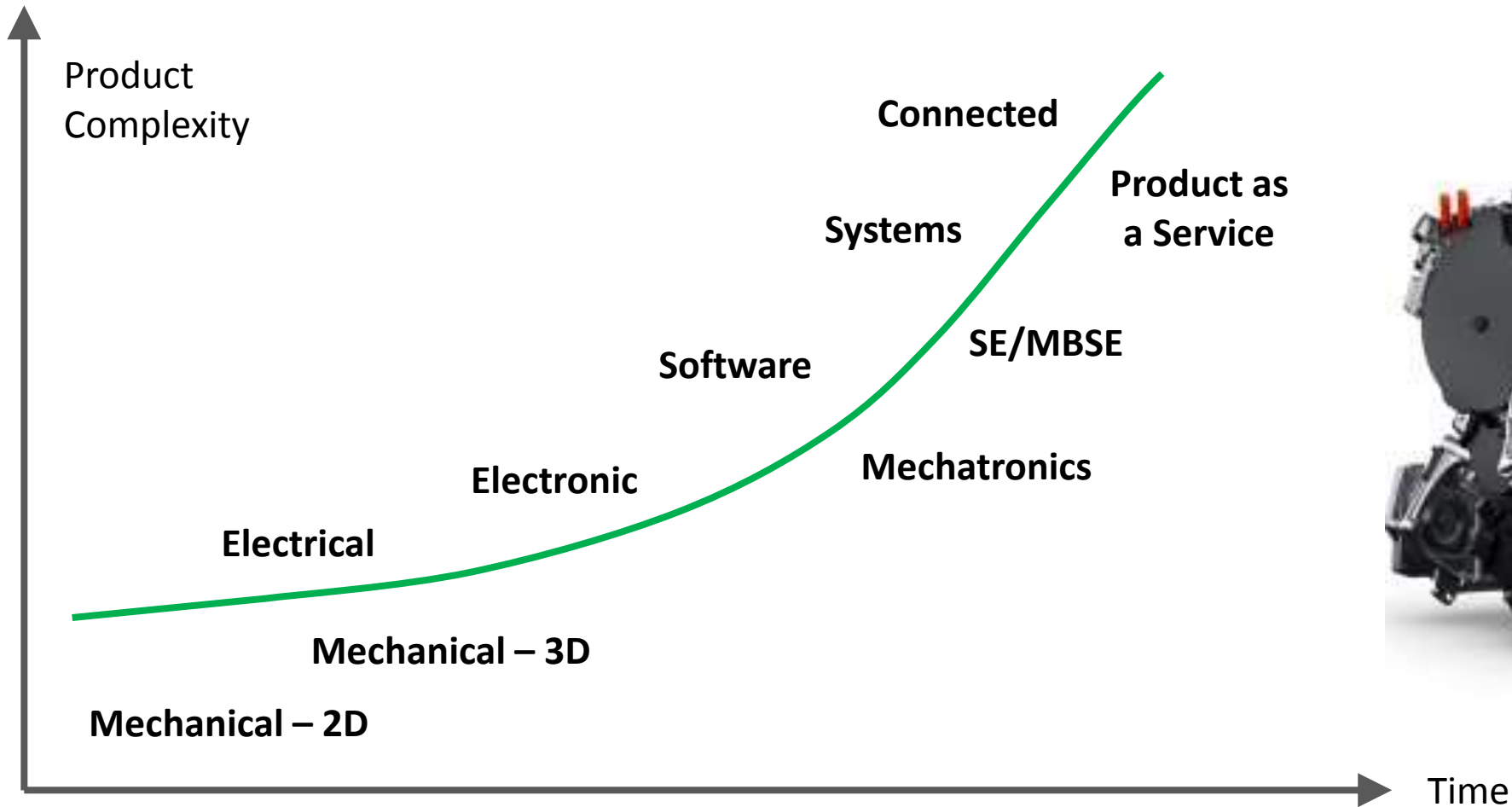

Why Treat BOMs as Strategic?

More disciplines to cover than ever before



Mechanical Design	Procurement	Technical Documentation	Logistics
Thermal Analysis	Reliability Engineering	Software Development	Contract Deliverables
Program Management	Materials Management	Test Methods	Manufacturing Engineering
Field Service	Electronics Design	Portfolio Management	Costing
Software Testing	Quality Assurance	Kinematics	Fluid Dynamics
Systems Engineering	Supply Chain Management	Customer Service	Warranty Management
Structural Analysis	Production	Process Planning	Environmental Compliance
Training	Wire Harness	Industrial Design	Product Marketing
Mass Properties	Regulatory Compliance	Sales	Release Management
Tooling	Facilities Management	Inventory Control	Simulation Management

Why Treat BOMs as Strategic?

Communication with globally distributed supply chains

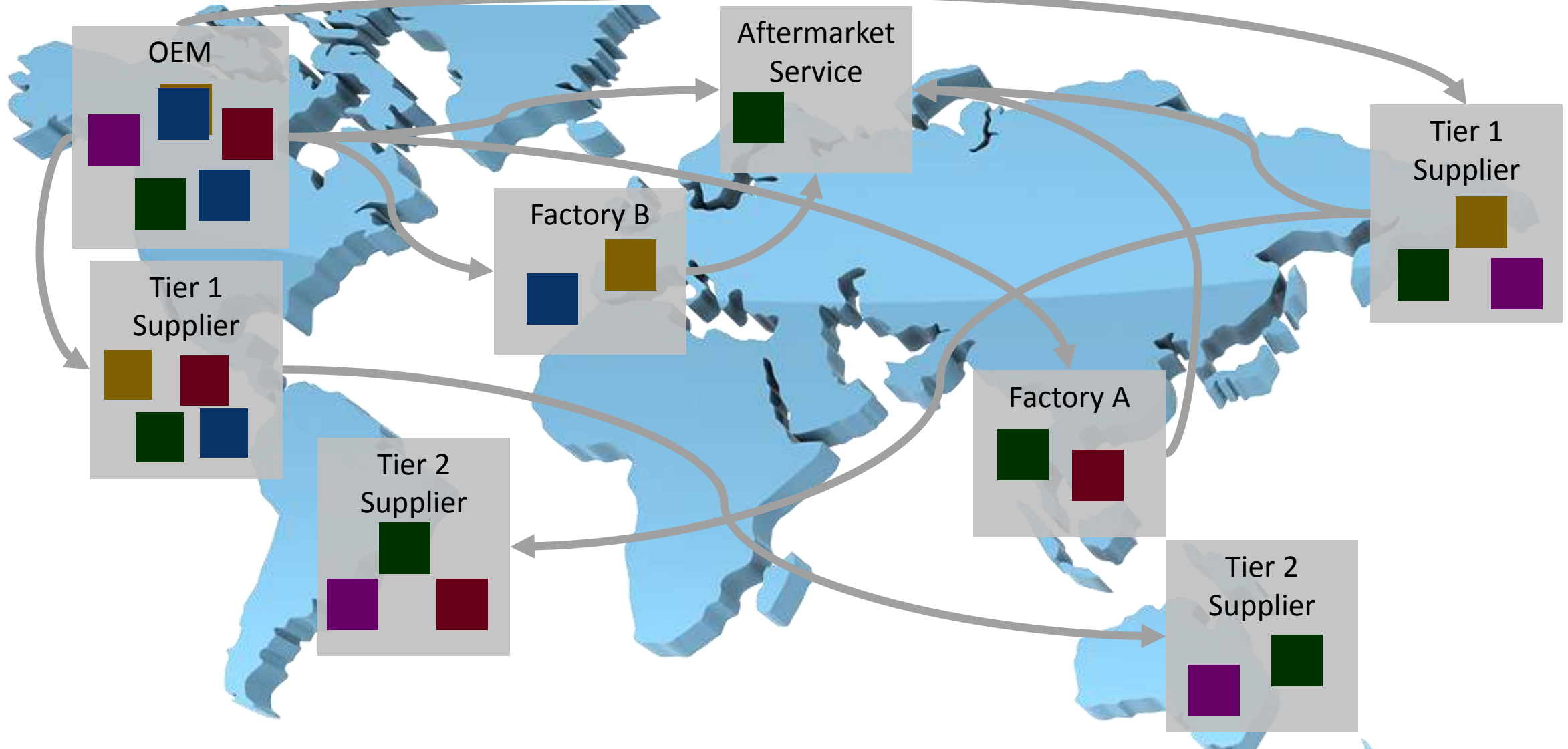

Why Treat BOMs as Strategic?

Too many gaps in the product lifecycle

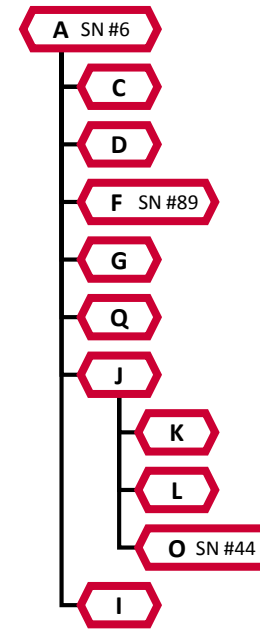
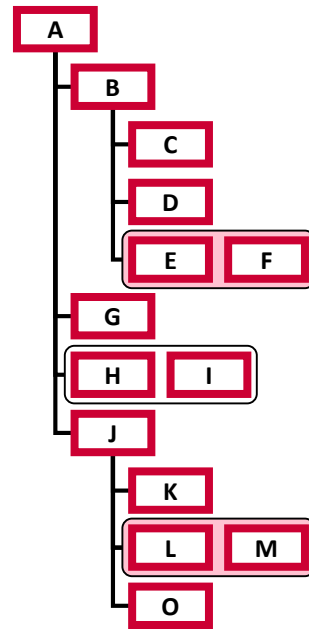
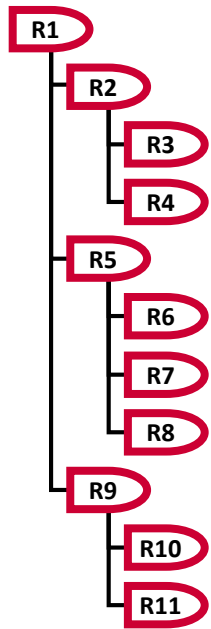

Requirements

As Designed

As Built

Step 1: Get Disciplined

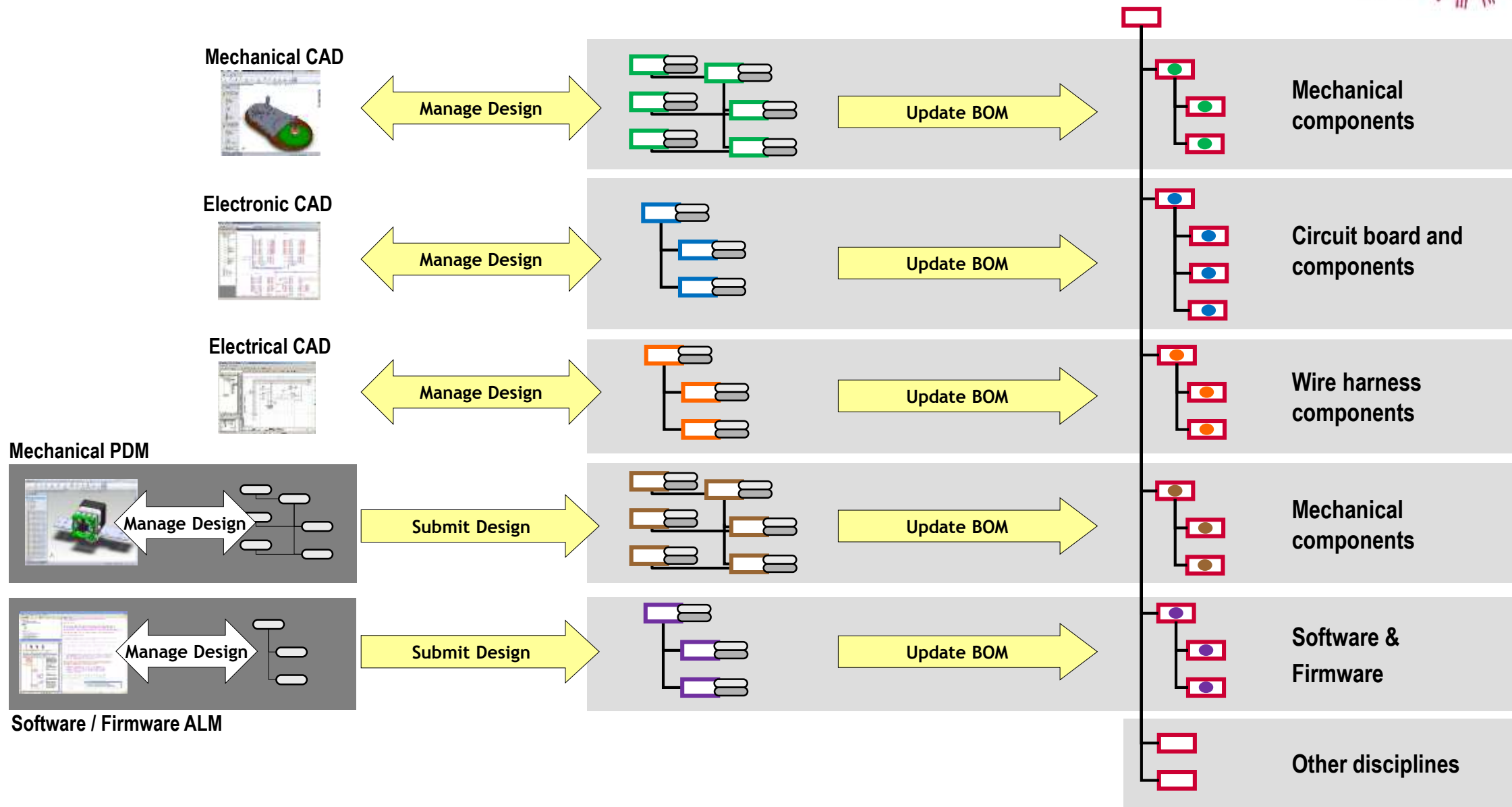

Step 2: Connect your MBOM

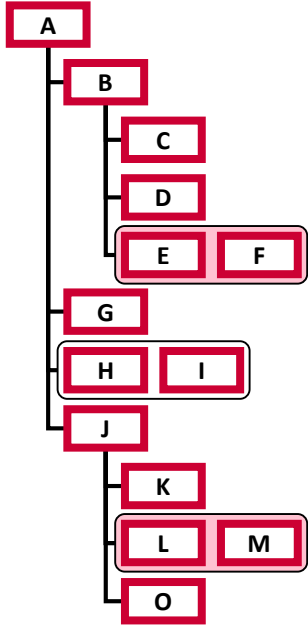

As Designed

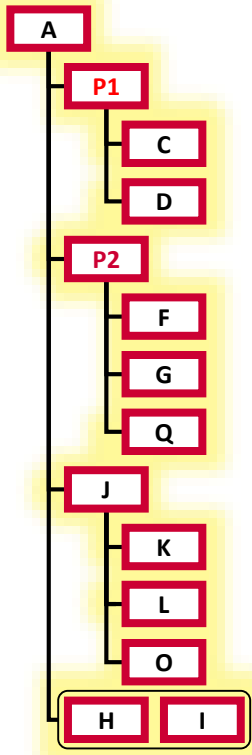

As Planned

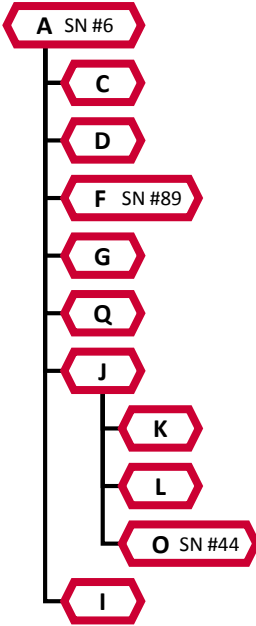

As Built

Process Plan Step Struder M01

Work Order #	Part	Effective Date	Approved by	Comments
3-3422	Austin	11/01/2015		

OP10 - Assemble Drive Head

1.1 Place the Drive Gear in the Stepper Motor

1.2 Place the drive block front on the Motor assembly

Part Number	Part Name	Type	Quantity
P1	Motor Assembly	Phantom	1
M03	Drive Block	Component	2

Tool Number	Name	Quantity
M012	Wrench	1

OP20 - Assemble Bar Mount and Thermal Barrier

2.1 Loosely thread the M6 nut onto the thermal barrier

Workbench

Part Number	Name	Rev	M/B	Type	Quantity
M17	Body Assembly	A	Make	Assembly	1
M32	Hardware Ass...	B	Make	Assembly	1

Step 3: Connect Requirements to EBOM

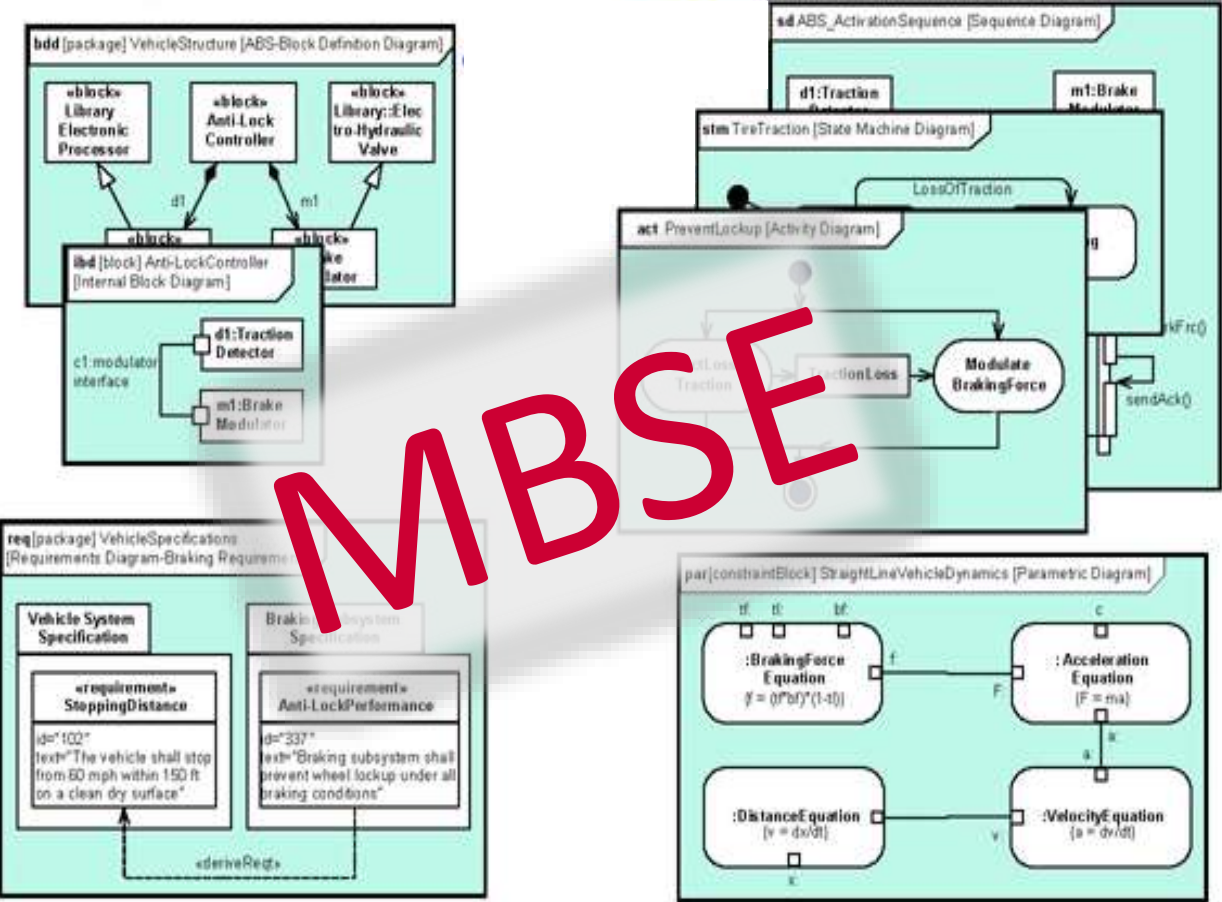

MBSE

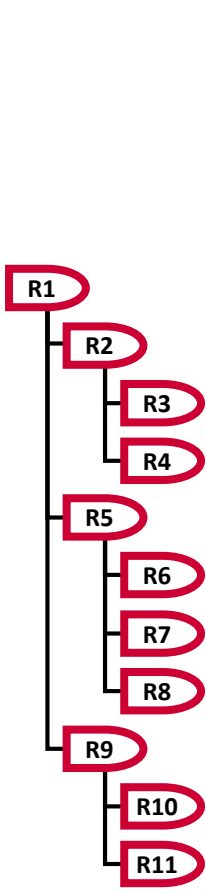

Requirements

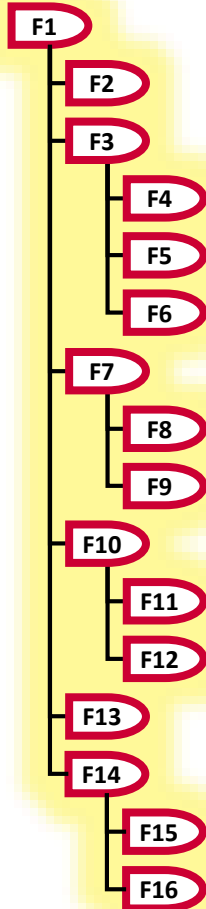

Functional

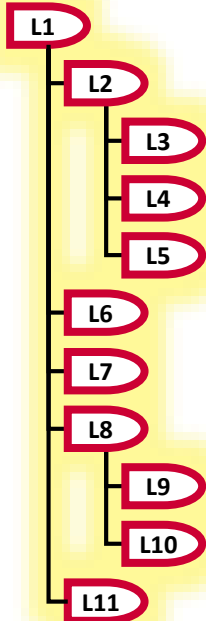

Logical

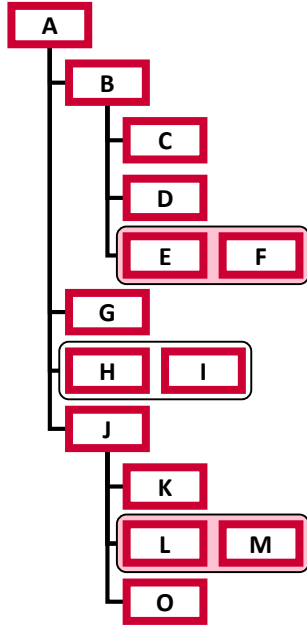

As Designed

Step 4: Apply Enterprise Access Control



TRADE SECRET

SUPPLIER 2

SUPPLIER 1

SUPPLIER 3

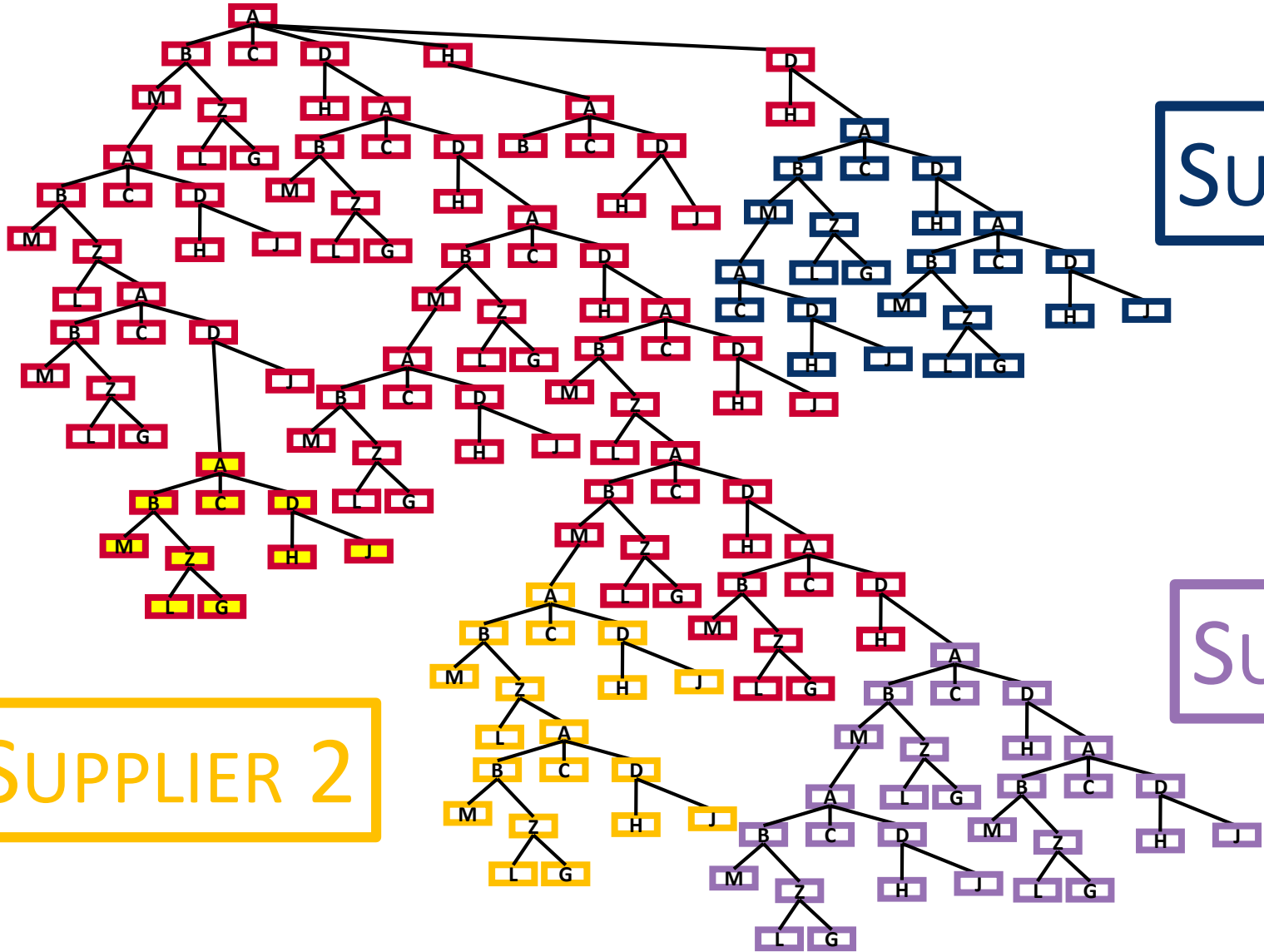

Step 5: Extend Beyond the Factory

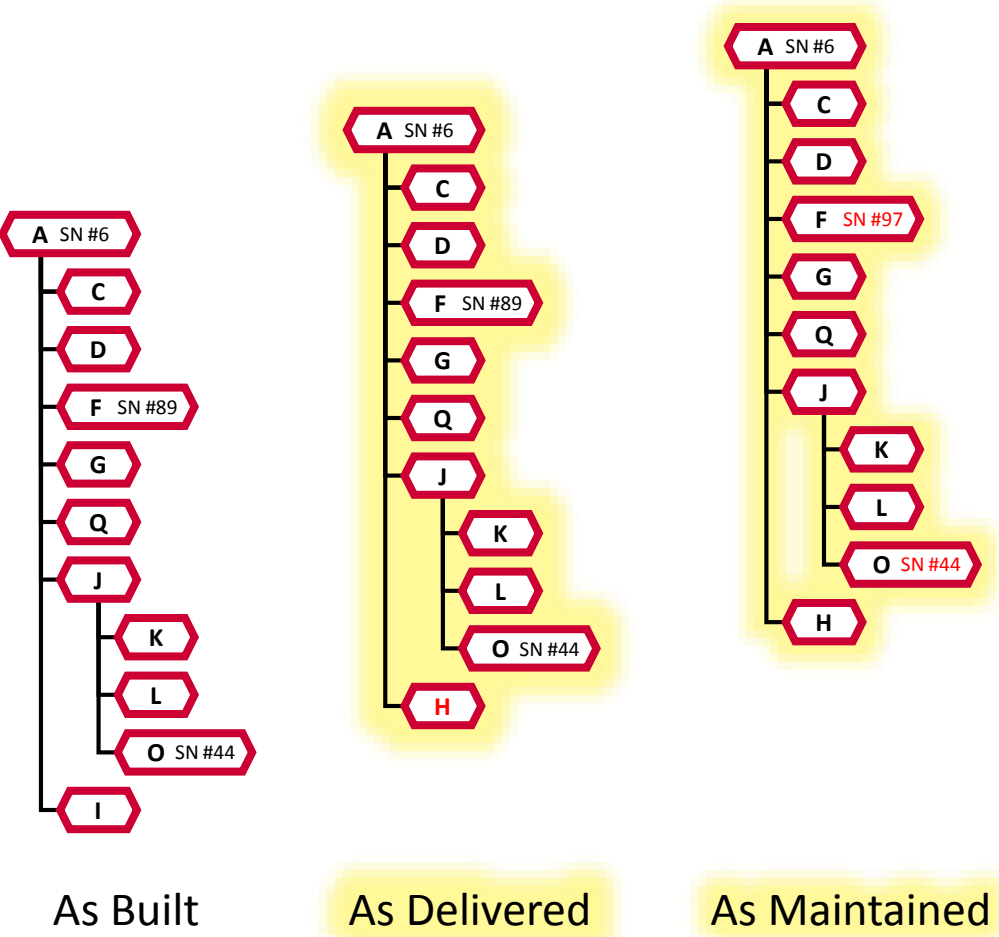

MAINTENANCE

SERVICE

REPAIR

CORRECTIVE

OVERHAUL

PREVENTIVE

OPERATIONS

TEST

DELIVERY

IoT

REWORK

QUALITY

The Result: Full Lifecycle Traceability

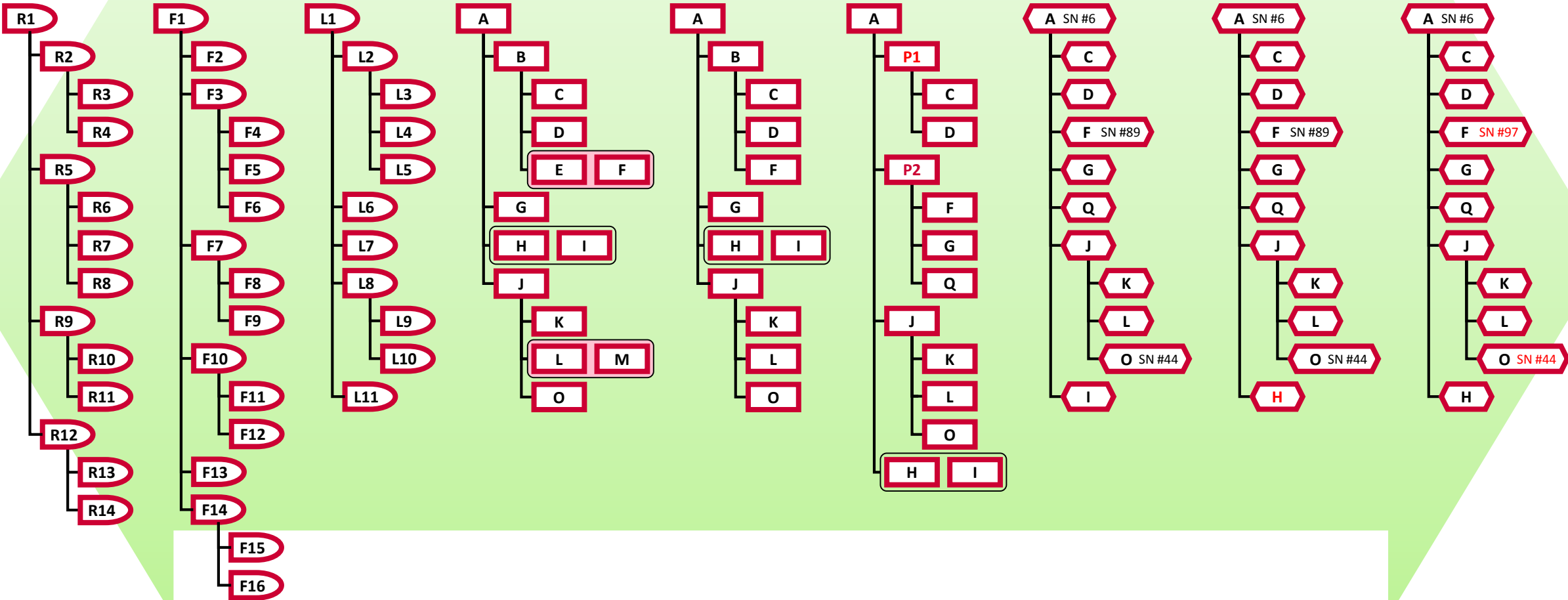

REQUIRED FUNCTIONAL LOGICAL AS DESIGNED AS ORDERED AS PLANNED AS BUILT AS DELIVERED AS SERVICED

Conclusions

- Your Product BOM is a strategic asset
 - Not a technicality
 - Not a document

- Strategic BOM Management forms the basis for
 - Interdisciplinary communication
 - Supply chain integration
 - Reconciliation between lifecycle phases
 - Enterprise access control
 - Full lifecycle traceability

INNOVATION
WITHOUT LIMITATION